



# LF140e

**LABEL FINISHING SYSTEM**

## **User's Manual**

©2021, DTM Print GmbH. All rights reserved

For the most recent version of this manual please visit [dtm-print.eu/manuals](http://dtm-print.eu/manuals)



---

**Notices:** The information in this document is subject to change without notice. NO WARRANTY OF ANY KIND IS MADE WITH REGARD TO THIS MATERIAL, INCLUDING, BUT NOT LIMITED TO, THE IMPLIED WARRANTIES OF MERCHANTABILITY AND FITNESS FOR A PARTICULAR PURPOSE. No liability is assumed for errors contained herein or for incidental or consequential damages in connection with the furnishing, performance, or use of this material. This document contains proprietary information that is protected by copyright. All rights are reserved. No part of this document may be photocopied, reproduced, or translated into another language without prior written consent.

**Trademark Acknowledgments:** Primera and Primera LX610e are registered trademarks of Primera Technology, Inc. Windows is a registered trademark of Microsoft Corporation. All other trademarks are the property of their respective owners.

### **Revision History**

Edition 1.0, Copyright 2021, All rights reserved.

# Table of Contents



<b>Section 1: Getting Started</b> .....	5
1A Choosing a Good Location.....	5
1B Unpacking and Inspection.....	6
<b>Section 2: Media, Knives and Blades</b> .....	6
2A Media Path.....	7
2B How to load the Media and Lamination.....	8
2C Metal Guides Alignment.....	10
2D Loading the Rewinder Core Holder and Waste Matrix Core Holder.....	10
2E Setting the Slitter Module and Edge Slitting.....	11
2F How to Load the Media and Lamination.....	13
2G Remove Unwanted Waste from the Edge of the Roll.....	13
2H How to Add or Remove a Blade Holder.....	14
<b>Section 3: DTM LF140e Cutting Manager</b> .....	15
3A Overview.....	15
3B Advanced Settings.....	16
3C 3C Settings (A).....	17
3D Update Software.....	20
<b>Section 4: Cutting</b> .....	21
4A Cutting File Specifications.....	21
4B Create Print and Cut Files.....	21
4B1 Print File.....	21
4B2 Cut File.....	22
4B3 Print.....	22
4C Load Cutting File.....	23
4D Adjust the plotter feeding speed.....	23
4E Black mark detection.....	23
4F Blank labels.....	24
4G Run the cut test.....	24
4H Adjust knife pressure.....	24
4I Adjust offsets.....	24
<b>Section 5: Troubleshooting and Maintenance</b> .....	25
5A Graphtec plotter maintenance (clean/adjust knife).....	25
5A1 Cutter Plunger.....	25
5A2 Mounting the tool.....	26
5A3 Removing the tool.....	27
5A4 How to replace the knife.....	27
5A5 How to replace the slitter blade.....	28
5A6 How to replace the cutting mat.....	28
5A7 Ultrasonic Sensor Calibration.....	29



---

5A8 Ultrasonic Sensor Calibration .....	29
5A9 Modules Speed Rotation .....	30
5B Error messages .....	31
5C Troubleshooting .....	32
5C1 Yellow and Green LED's simultaneously on lamination control board .....	32
5C2 Media Sensor .....	32
5C3 Laminating Sensor .....	33
5C4 Media not aligned properly .....	33
5C5 Plotter error E01017 Hardware X Position Alarm Power off then on .....	33
5C6 Plotter is not cutting or Plotter cutting all the way through the material .....	34
5C7 Plotter error E01019 Hardware Y Position Alarm Power off then on .....	35
5C8 Plotter error E05004 Hardware Realign Push Rollers Confirm .....	35
5C9 Cutting Manager error Black-mark not found .....	35
5C10 The Media or Lamination roll might be finished, please check it. Proceed with cutting? .....	36
5C11 Can't load sensors .....	36
5C12 Last job not found .....	36
5C13 Please forward the media to the next black-mark .....	37
5C14 Please forward the media to reach a positive Y value shown on the plotter's display .....	37
5D How to Restore Plotter Settings .....	38
<b>Section 6: Technical Specifications .....</b>	<b>40</b>

# Section 1: Getting Started

---

## THANK YOU...

...for choosing an LF140e Label Finishing System. The LF140e is a compact system for simple, fast and cost-efficient label processing on-site. It can be used to handle all the operations involved including unwinding the pre-printed rolls, laminating and digital contour cutting, waste matrix removing, slitting and rewinding the finished rolls.

This User's Manual is your complete step-by-step guide to quickly and easily setting up and finishing with your new Label Finishing System!

## 1A Choosing a Good Location

- ▶ Place the finisher on a flat surface in a location with adequate air circulation to prevent internal heat buildup.
- ▶ Do not place the finisher near heat sources such as radiators or air ducts, or in a place subject to direct sunlight, excessive dust, mechanical vibration or shock.
- ▶ Make sure that you have enough space around the system so that you can operate it from all sides.

## 1B Unpacking and Inspection

For the video instructions to unpack and setup the finisher scan the QR code or enter the following link in your internet browser: [https://youtu.be/DWJm\\_UfPx-s](https://youtu.be/DWJm_UfPx-s)



While unpacking your finisher, inspect everything to ensure that no damage has occurred during shipping.

## 1C Identifying the Parts

These illustration shows the printer from various angles so all important parts can be identified.

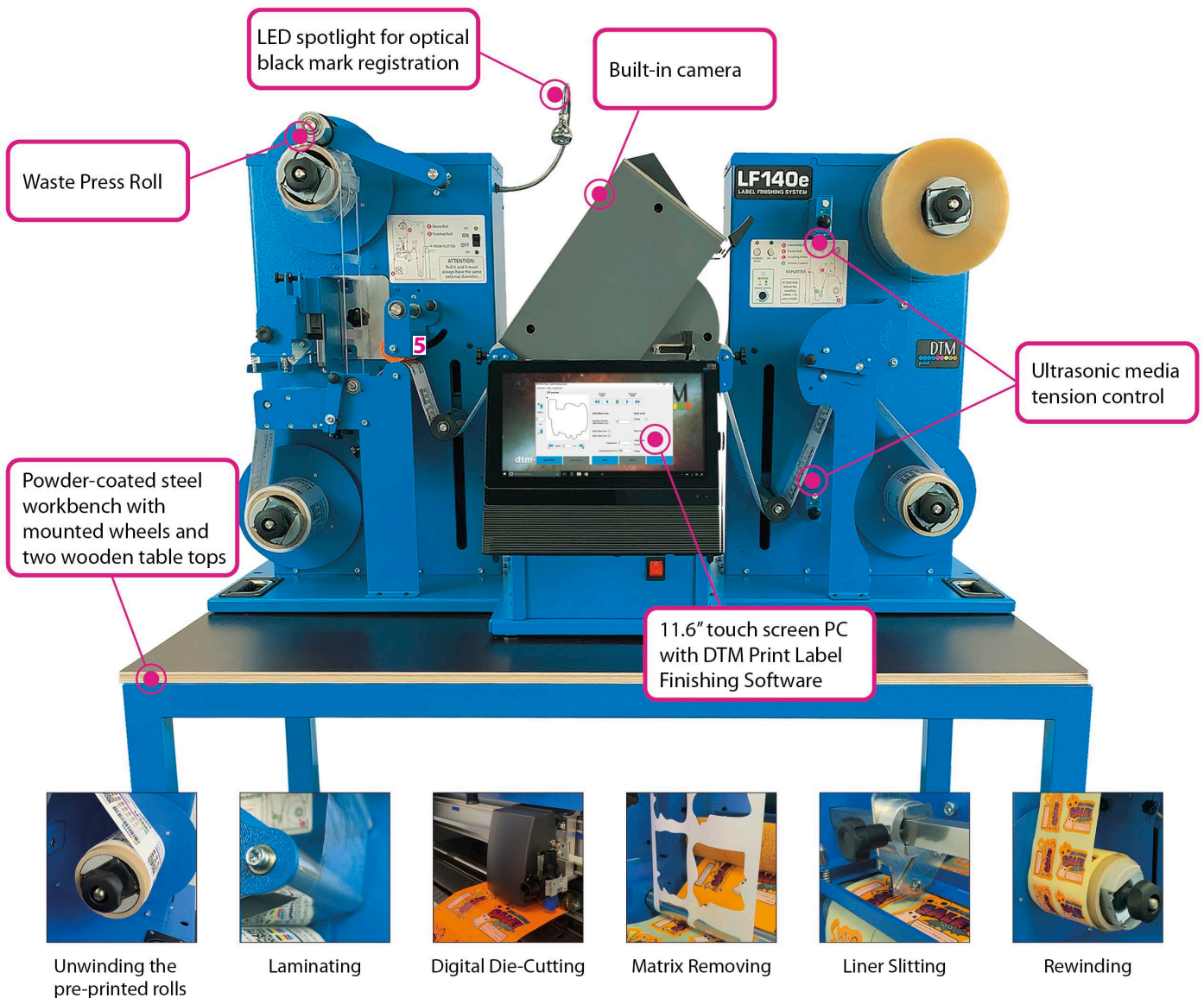

# Section 2: Media, Knives and Blades

## 2A Media Path

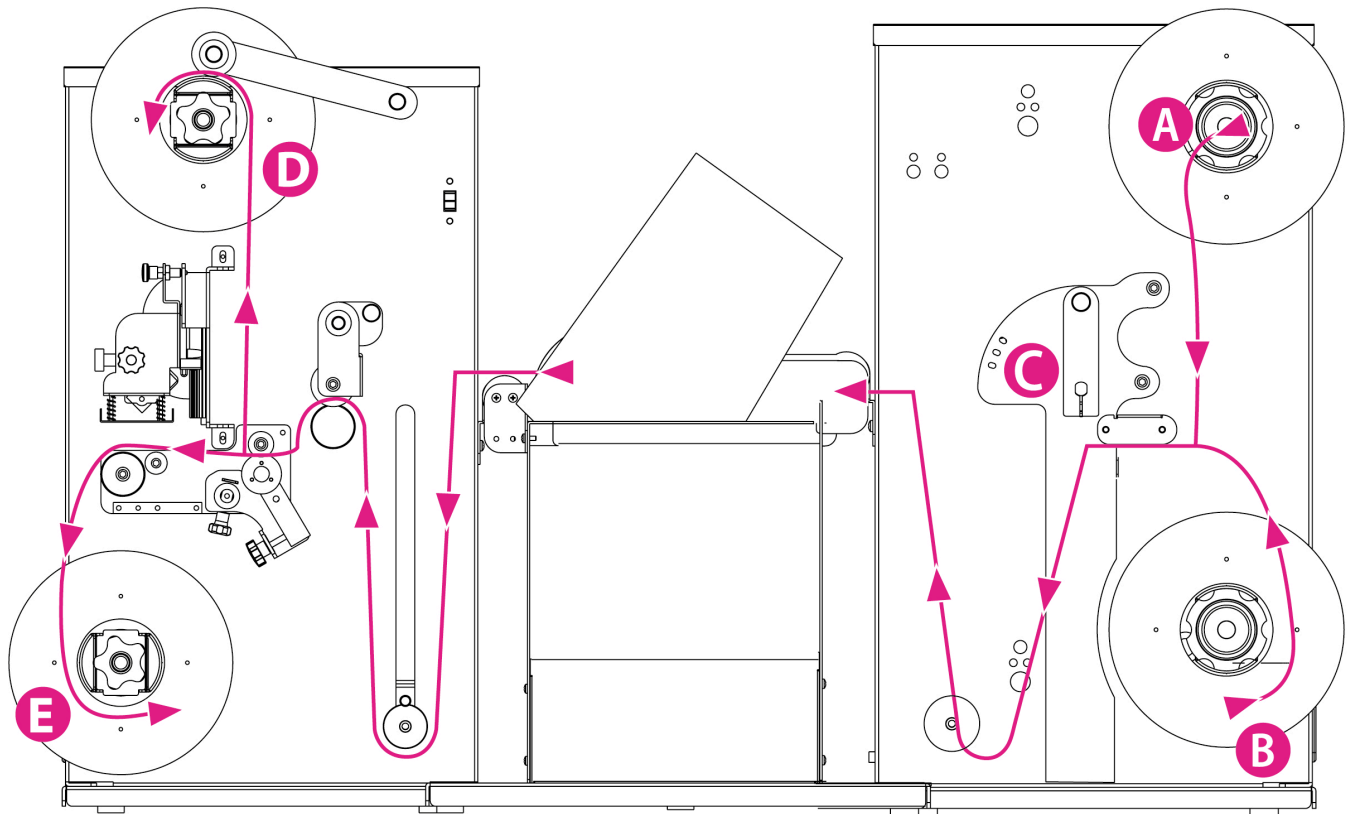

- D** Waste Roll
- E** Finished Roll

**ATTENTION:**  
Roll **D** and **E** must always have the same external diameter.

- A** Laminating Roll
- B** Printed Roll
- C** Coupling Roller

**ATTENTION:**  
Adjust the coupling rollers **C** to your needs.

## 2B How to load the Media and Lamination



Load the printed roll against the stopper plate. Tighten the core holder.



Load the lamination roll, move it along the supply shaft and make it match with the web, tighten the core holder until it is centered to the printed roll.

**Important:** The lamination roll always needs to be narrower than the web with



Load the media into the nip rollers.



Hold the laminating film with both hands, pull it underneath the guide roller, center it and adhere the laminating film to the web. For any doubt, please refer to the lamination and media drawing.



While using the knob, please adjust the pressure on the rollers in order for the laminating film to adhere to the media and avoid any possible air bubbles. We recommend the middle hole position, as shown in the picture.



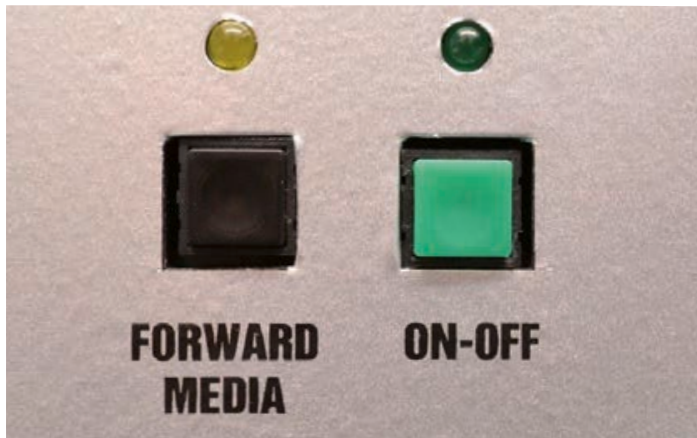

When both LEDs are off, the manual media feeding is active. Use "Forward Media" button to feed some material.

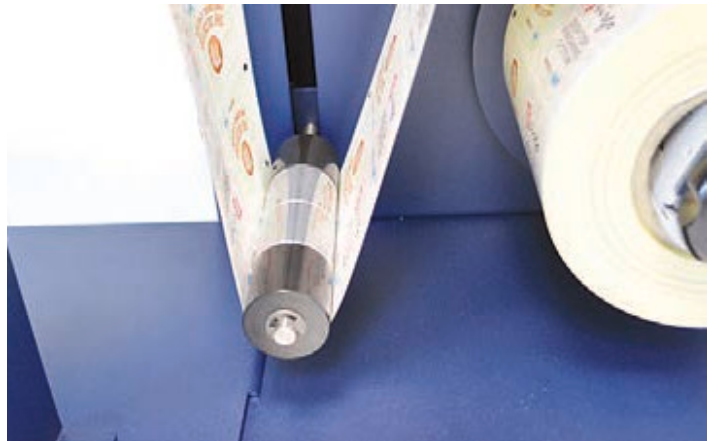

Pull the laminated media under the tension arm.



Pass it between the aluminium rollers. The guide can be adjusted to prevent the media from shifting.



Put the lever, located in the rear of the plotter, in the down position.



Pull the media through the plotter, keeping the media edge in contact with the alignment points.



Set both pinch rollers at about 2 mm from the media edge.



While holding the media in the aligned position with one hand, lift the handle on the rear of the plotter with the other to secure the media



Press button 2 as requested on plotter's display.

## 2C Metal Guides Alignment

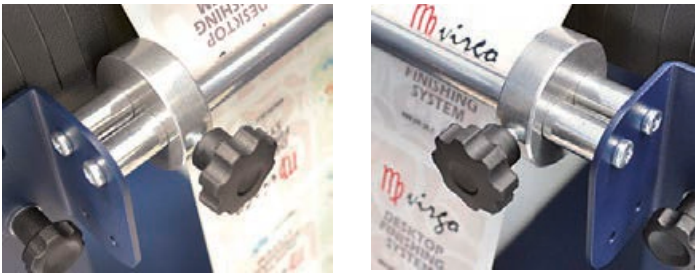

Media guides should be adjusted in order to prevent the web from shifting position.

## 2D Loading the Rewinder Core Holder and Waste Matrix Core Holder

**WARNING:** Before starting a job, always remove the waste media from the matrix remover core. Tape the matrix securely onto the cardboard core. System operating issues may occur if the above suggestions are not followed.



Load empty cardboard core(s) and tighten the core holder, then place the motorized core holder in position.



Peel back the matrix.



Pull the matrix and attach it to the matrix remover core holder.

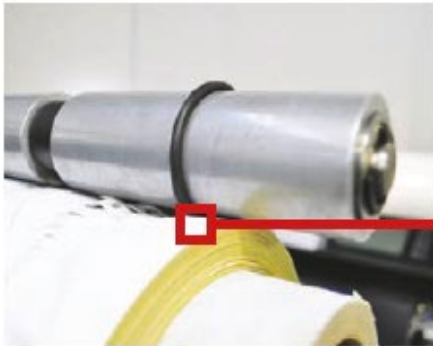

Pull down the waste press.



Relocate the o-rings to be over the waste matrix.



Close the sponge roller.

## 2E Setting the Slitter Module and Edge Slitting



Load empty cardboard core(s) and tighten the core holder, then place the motorized core holder in position.



Pull the media through the aluminium rollers.



Attach the labels to the core using a waste label.

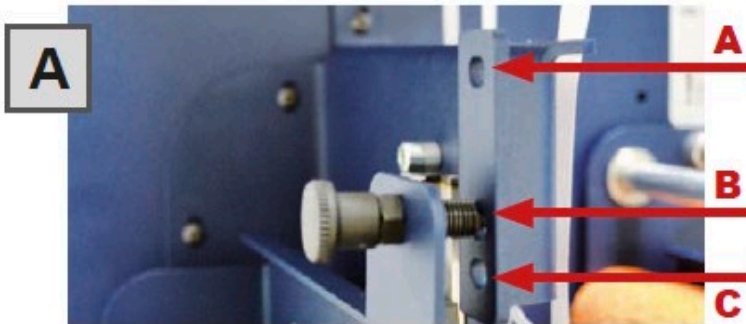

Slitter module has 3 positions:

Upper position (A), the blades are lifted to allow the media loading;

Middle position (B), align the blades with the edges and the center of the labels, tighten the thumb screw once the blade is in position;

Lower position (C), the blade cut the media.



Turn ON the Matrix Remover module to rewind and start to slit the media, then turn OFF

Cut the labels when the first "good" labels are visible.

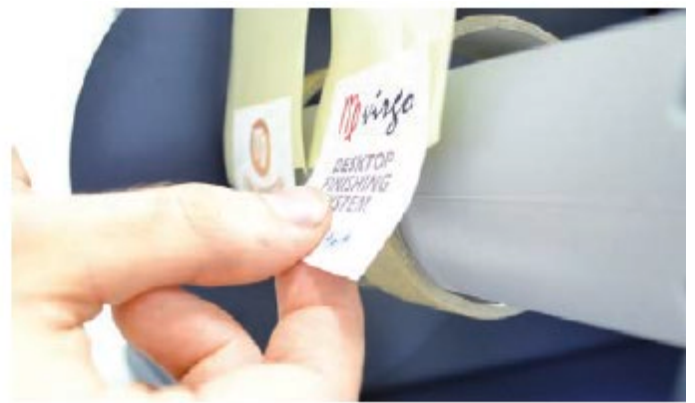

Make sure the tension on all rolls is even, and attach each label to the core using a waste label or tape.

Turn the Matrix Remover module ON. Press Resume to continue.

## 2F How to Load the Media and Lamination

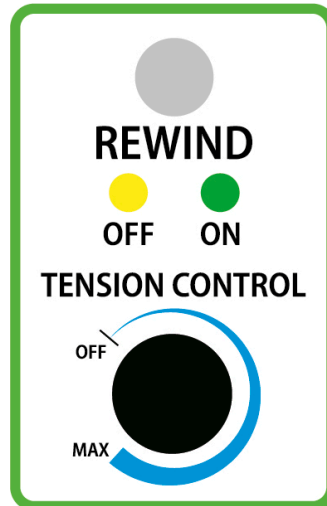

Manual Core Holder  
Rotation/Rewind

Yellow LED - Tension Deactivated  
Green LED - Tension Activated

Clutch Adjustment  
+ : Tension Increasing

It is important to keep the media and laminating film under tension using the clutch adjustments. If the tension is too tight, the roller system may be damaged; if the tension is too loose, the media will not be laminated properly.

## 2G Remove Unwanted Waste from the Edge of the Roll

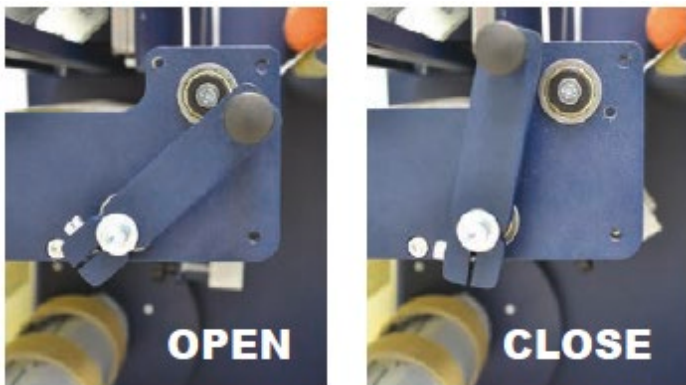

Use the backslider to remove unwanted waste from the edge of the roll.

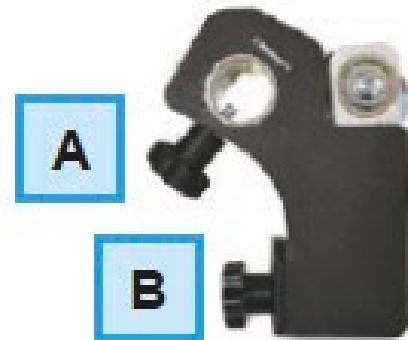

A = Knob used to secure the position after choosing desired width

B = Knob to increase or decrease the cutting force Tighten knob "A" to secure the position after choosing desired width.



Tighten knob "A" to secure the position after choosing desired width .



Use knob "B" to increase or decrease the force on the support.  
 Clockwise: Increases the cutting force  
 Counterclockwise: Decreases the cutting force



If done correctly, you should achieve the results displayed in the photos.

**WARNING:**  
 The cutting force of these blades are already calibrated for standard use.

## 2H How to Add or Remove a Blade Holder



Remove the iron bar by unscrewing the black thumb screw.



Slide the blade holder on or off. Replace the slide iron bar and rescrew the thumb screw

# Section 3: DTM LF140e Cutting Manager



## 3A Overview

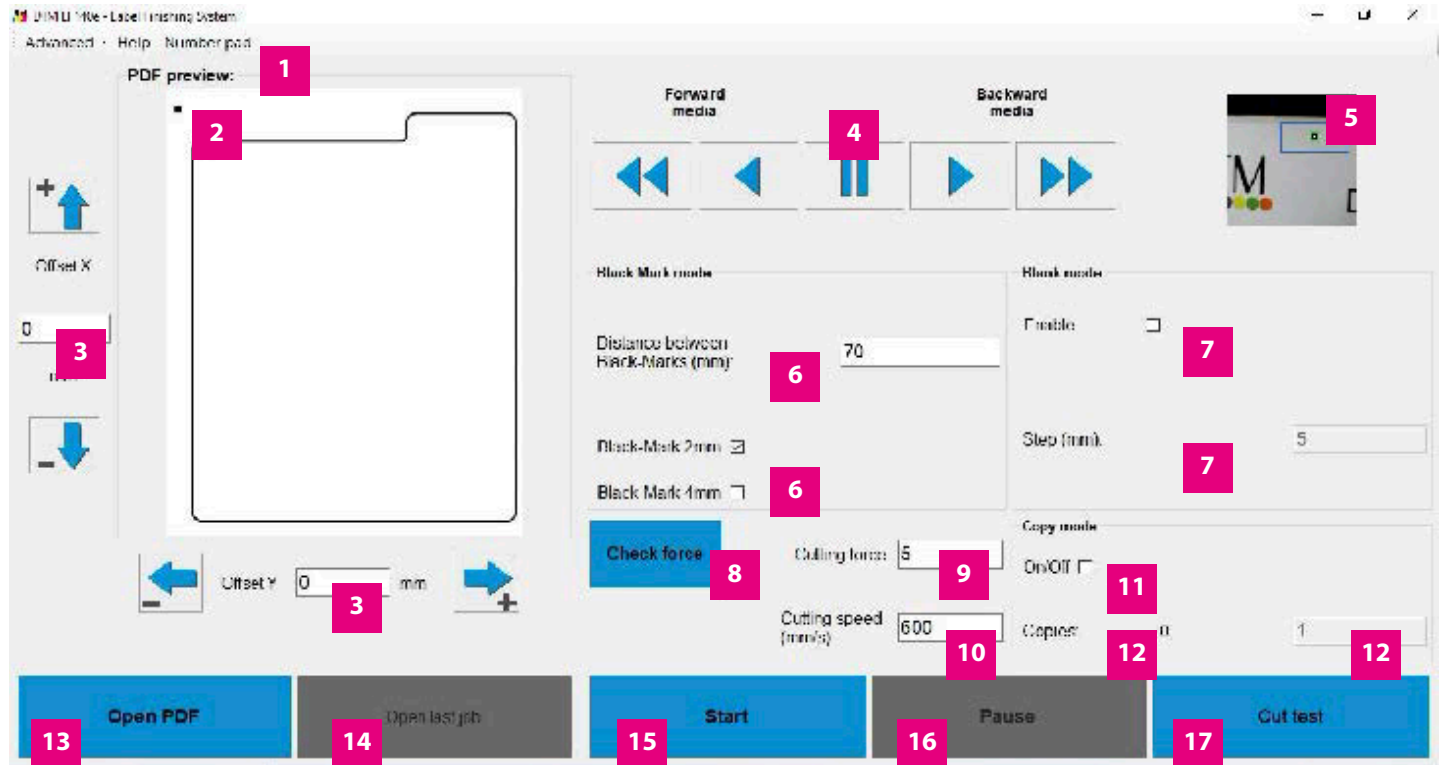

- 1 Advanced settings
- 2 Cutting file preview
- 3 Alignment adjustment controls
- 4 Controls to move the media forward or backward
- 5 Camera preview
- 6a Set the distance between each black-mark
- 6b Set the size of the black-marks
- 7a Enable or disable blank mode
- 7b Set the distance between each label
- 8
- 9 Set the blade strength and increase the cutting depth. It can be set from 1 to 31. The most common values are from 7 to 9
- 10 Set the cutting speed. Can be set from 50 to 600. The most common value is 600. If you have a cutting force major than 9, you may need to decrease the speed for a proper precision
- 11 Flag to determined number of copies to cut during a cutting job launched with the "Start" button, otherwise the plotter will continue and stop at the end of the media
- 12 Counts the number of copies cut since pressing the "Start" button
- 13 Selects the cutting file
- 14 Open the last cutting file
- 15 Start/Cancel button. Used to launch or stop a cutting job
- 16 Pause/Resume button. Used to pause or resume the cutting job
- 17 Used to launch a single cut to let the user check the cutting parameters



About 3 - Alignment adjustment controls

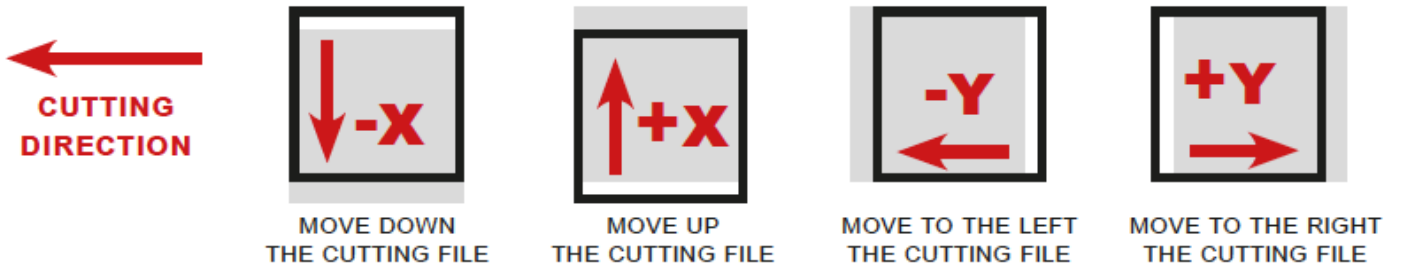

3B Advanced Settings

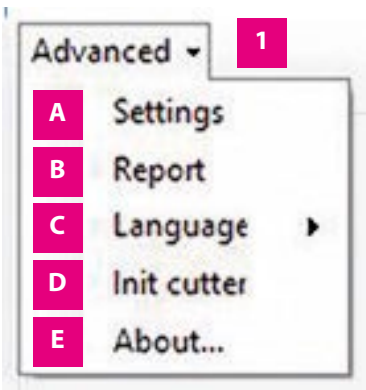

- A Settings
- B List of cut logs
- C Set interface's language
- D Restore of the plotter's settings
- E Additional information



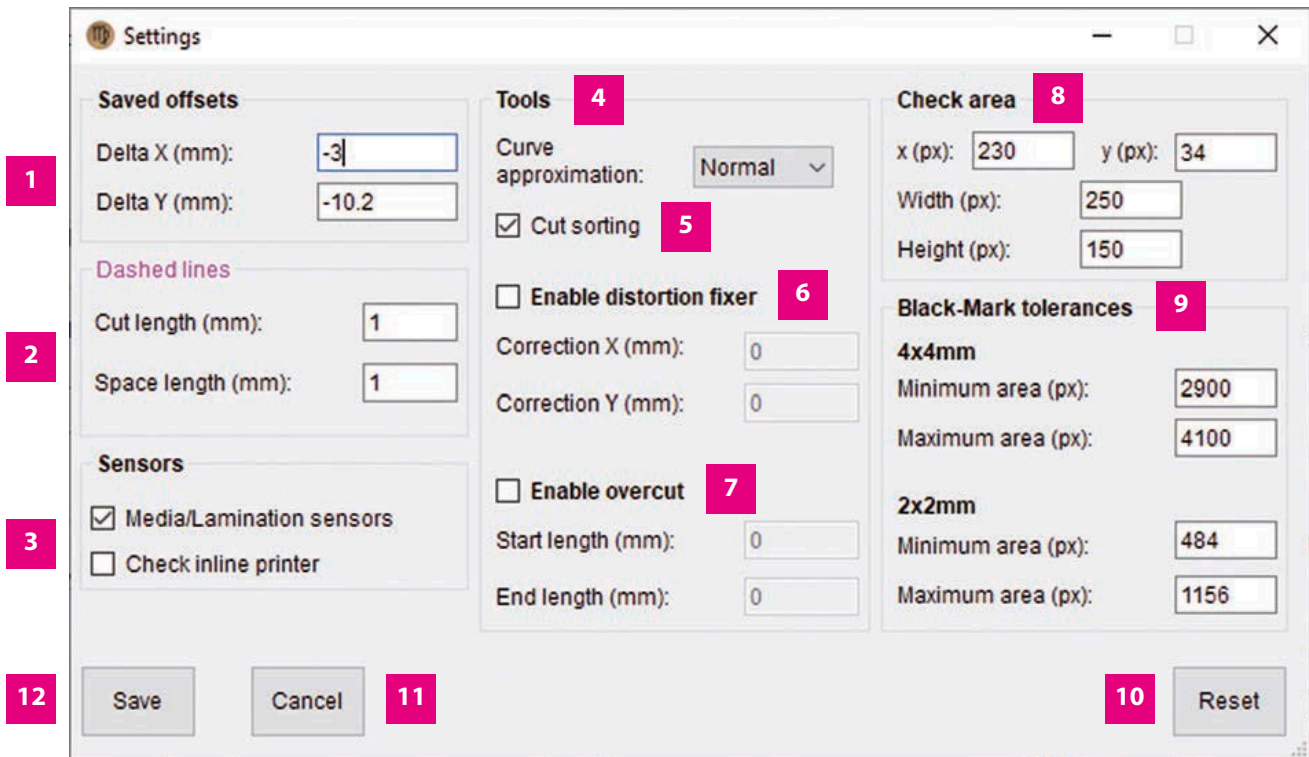

### 3C Settings (A)

1. When you launch a cut with new offsets, they will be added to the deltas. The deltas store the saved offsets.
2. All the 100% magenta lines in your cutting file will be recognized as dashed. Here you can set the cut length and the spacing between each one of them. They must be at least 0,1 mm, and not more than 819 mm.
3. Here you can choose to enable or disable the media or lamination sensors. If "Media/Lamination sensors" is checked, when the material ends, the software stops the cut and will give you an alert.
4. Approximation of the cut curves.
5. If cut sorting is enabled, the software will automatically select the order of the cut of all the shapes on the file. Otherwise, the cut will follow the .pdf layers order.
6. When you print your rolls, sometimes you may have distortion on your output. In that case, even with a correct set of the offsets, the cut may not match your print. You will have to enable the distortion fixer, and set the corrections. A positive value will stretch the cut on that axis, otherwise with a negative one, the cut will be more compressed.

X Axis

Cutting Direction

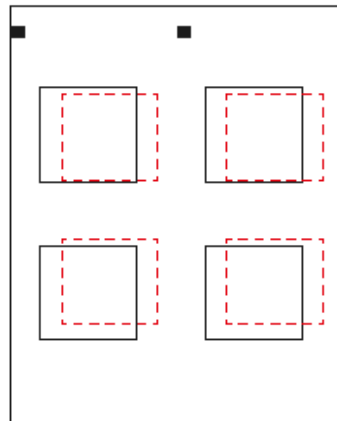
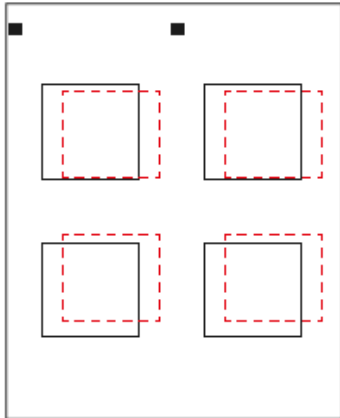

**STEP 1**  
VERIFY THE  
CORRESPONDENCE OF  
THE CUT WITH THE PRINT

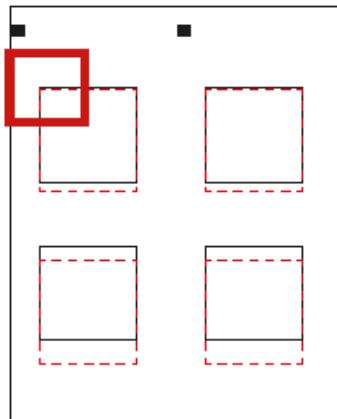
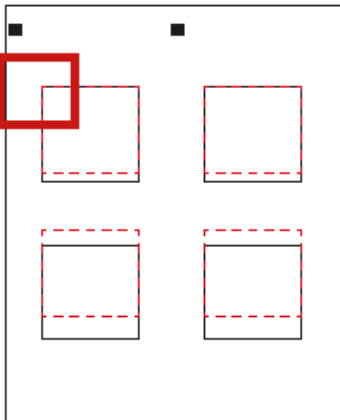

**STEP 2**  
AT THE POINT INDICATED,  
ADJUST OFFSET TO ALIGN  
THE CUT WITH THE PRINT

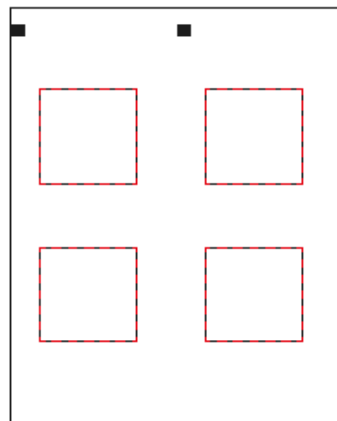
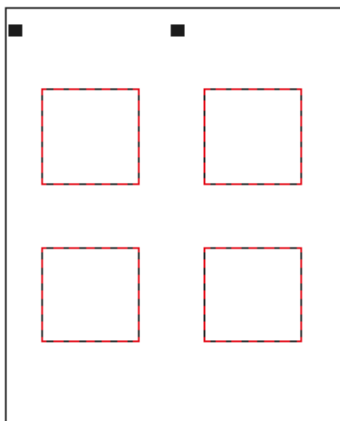

**STEP 3**  
INCREASE OR DECREASE  
THE "STRETCH"  
PARAMETER (X)

Y Axis

Cutting Direction

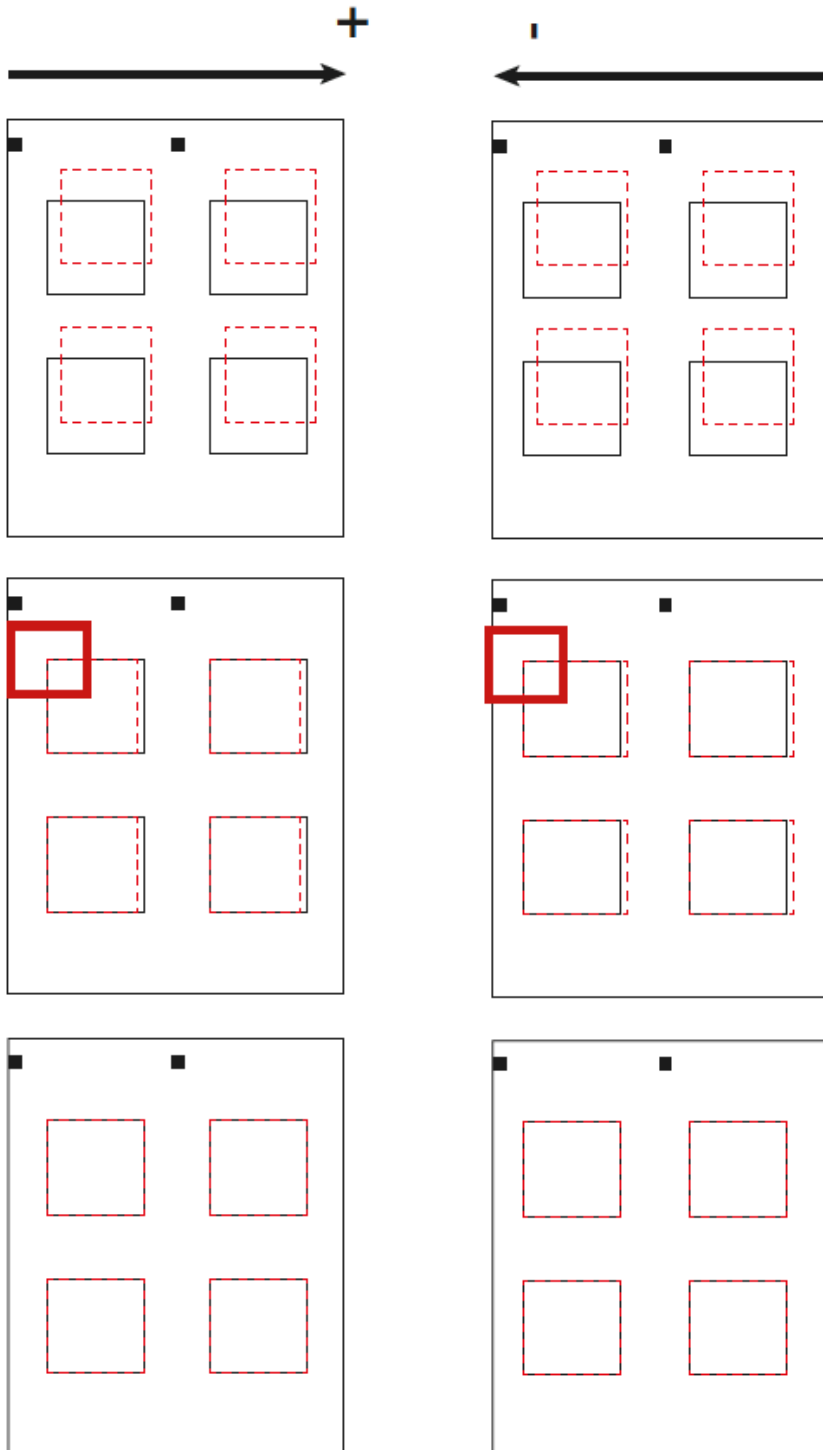

STEP 1  
VERIFY THE  
CORRESPONDENCE OF THE  
CUT WITH THE PRINT

STEP 2  
AT THE POINT INDICATED,  
ADJUST OFFSET TO ALIGN  
THE CUT WITH THE PRINT

STEP 3  
INCREASE OR DECREASE  
THE "COMPRESSION"  
PARAMETER (Y)

- 
7. With thin materials the cut may not be closed. To fix this, enable the overcut, and set how much you want the blade to start early, or end later. You can anticipate or delay the end of the cut up to 0,9 mm for each one.
  8. Check area parameters lets you change the position of the Black-Mark's checking area, which is the blue square shown in the camera preview while the blank mode is disabled. X and Y change the area top right origin point. X will move the area along the vertical axis, while Y on the horizontal. Height and width change the area dimensions. X must value at least 80, and Y 10. In case the sum of X and height is more than 560, or the sum of Y and width is more than 470, the area will not be built and the software will report that the parameters are not valid.
  9. In case your print has distorted the output of your blackmark, you can change the tolerances to let the cam recognize it. The tolerances must be positive values. If your blackmark side is smaller than 4 mm (for 4x4 mm) or 2 mm (for 2x2 mm), you will have to reduce the minimum area by 100, until the black mark is recognized. If your black mark side is higher than 4 mm (for 4x4 mm) or 2 mm (for 2x2 mm), you will have to increase the maximum area by 100, until the blackmark is recognized.
  10. Click to restore the default settings.
  11. Discard the changes and closes the window.
  12. Save the changes and closes the window.

## 3D Update Software

1. Go to Panel control.
2. Uninstall DTM LF140e Cutting Manager.
3. Download the new software from [dtm-print.eu/download](http://dtm-print.eu/download) and run the installation.

# Section 4: Cutting

## 4A Cutting File Specifications

Adobe Illustrator and/or Corel Draw (save as PDF file)

## 4B Create Print and Cut Files

To cut a label that has been pre-produced with an inkjet or dry toner printer, two separate files are required.



Print File

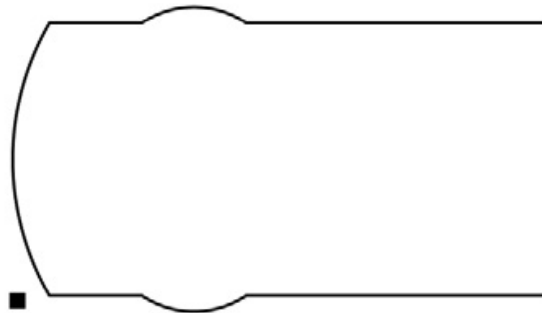

Cut File for the LF140e

### 4B1 Print File

#### Create the graphic design

Make sure to design your print files with the correct **colour mode** required by the label printer that will be used.

Try to keep the file size as small as possible, as this considerably reduces the processing time of the label before printing.

#### Create a black mark

Size: 4x4 or 2x2 mm

Position: on the bottom left

Colour: 100% black



Black mark can partially overlap the bottom of the label.

Minimum distance between label and black mark must be 4 mm.



Minimum distance between label and black mark must be 4 mm.

Round or complex labels:  
Black mark can partially overlap the left side of the label.



## 4B2 Cut File

### Create the cutline

Create a black stroke with **1 pt** thickness. Align the stroke to centre.

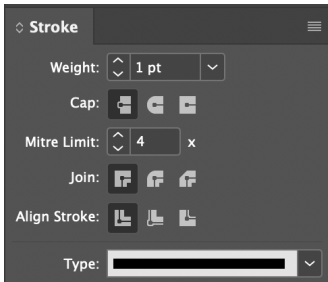

The cut file may **only** contain the cutline and the black mark. All graphic elements must be deleted.

### Examples

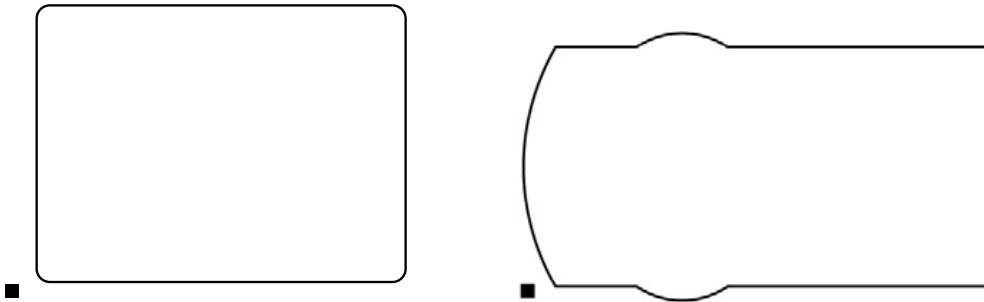

## 4B3 Print

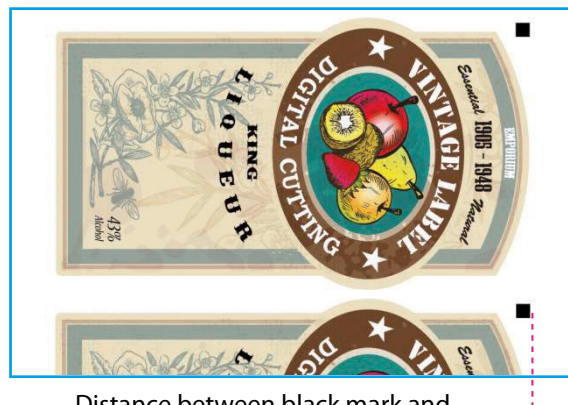

Media

Distance between black mark and right/left media edge: **5 - 10 mm**

## 4C Load Cutting File

1. Open DTM LF140 Cutting Manager.
2. Press "OPEN PDF" or "OPEN LAST JOB" to load the Cut File.
3. Look at the camera preview, hold down "BACKWARD MEDIA" or "FORWARD MEDIA" arrows to move the web until the black-mark goes in the centre position of the blue rectangle area.



4. Measure the distance in (MM) between the top of one black-mark to top of the next black-mark, key in this value in the "DISTANCE BETWEEN BLACK-MARKS" box section.
5. Make sure the "Enable" in the blank mode is unflagged

### IMPORTANT:

Whenever you lower and rise the lever while you are in black-mark mode, hold down the forward media arrow button to move again the plotter's head down

## 4D Adjust the plotter feeding speed

When cutting labels longer than 250 mm, it is recommend to decrease the cutting speed. The amount of reduction depends on the job in process. **The cutting speed can be set within the range of 50 to 600.**

## 4E Black mark detection

It is important that the camera is reading the black mark properly.

Look at the camera preview, hold down "BACKWARD MEDIA" or "FORWARD MEDIA" arrows to move the web until the black-mark goes in the centre position of the blue rectangle area.



## 4F Blank labels

To use the “Blank Label Mode” feature to cut blank labels (without a registration mark), follow these steps:

1. Import the cut file (without a registration mark) into the software.
2. Select the “blank label” feature from the software and enter the number of copies that you wish to cut.

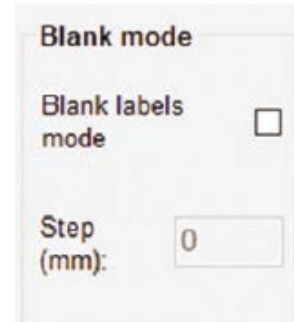
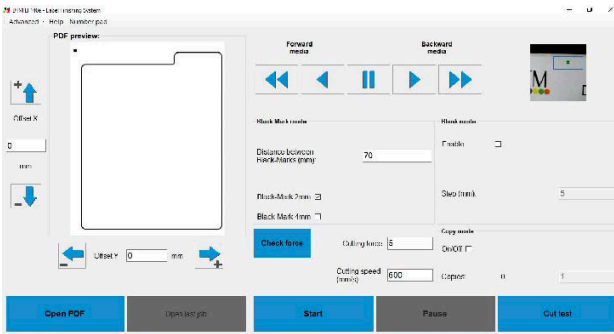

3. Click “Start”

## 4G Run the cut test

Press “CUT TEST” to check for cut depth. If the liner has been cut, decrease the cutter pressure value in the cut force box. If label doesn't detach, increase the cutter pressure value in the cut force box.

## 4H Adjust knife pressure

## 4I Adjust offsets

Make sure label is aligned with the cut. Through X and Y values in the software, adjust offsets if cut doesn't match label.

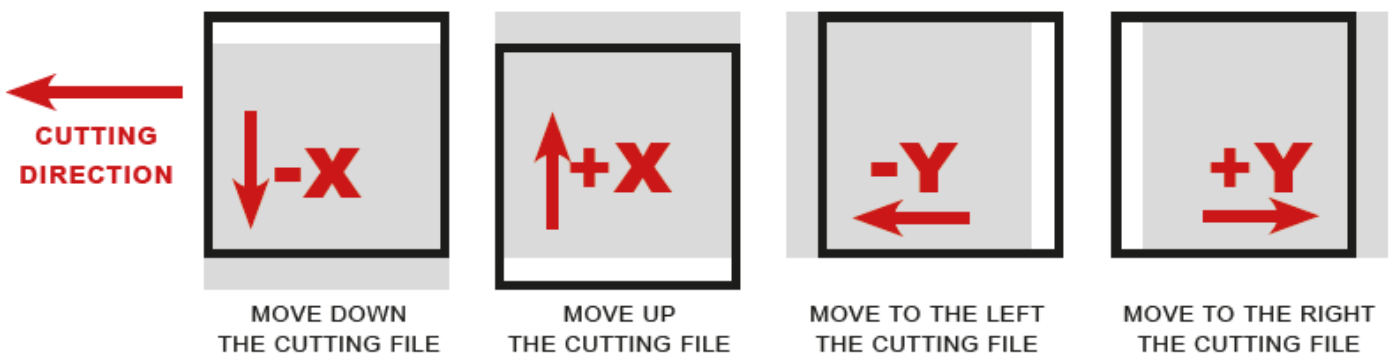

Once the cut settings are properly set, select “COPY MODE” ON if you desire a pre-set quantity of copies or OFF if to cut until the media roll is empty.

Set the black-mark size” in “BLACK-MARK MODE” area and Press “START”.



# Section 5: Troubleshooting and Maintenance

## 5A Graphtec plotter maintenance (clean/adjust knife)

### 5A1 Cutter Plunger

The plotter cuts using a cutter blade mounted in a plunger. There are two different plungers to suit the diameter of the cutter blade to be mounted (the 0,9 mm cutter plunger is provided as a standard accessory). Be sure to mount the cutter blade in the corresponding cutter plunger.

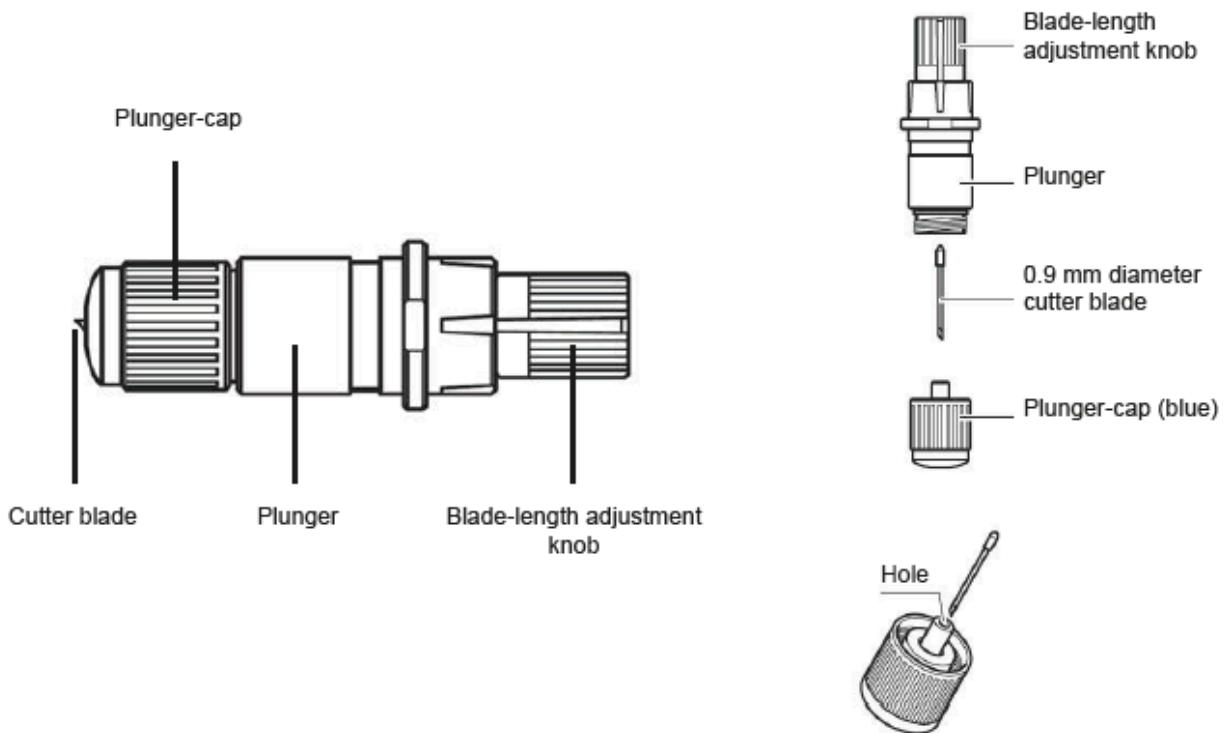

**CAUTION:**

To avoid bodily injury, handle cutter blades with care.

**WARNING:**

It may result in damaging the cutter blade or the cutting mat if the blade is extended too much. Make sure the blade length is set less than the thickness of the media.

Adjust the blade length by turning the blade-length adjustment knob. Turn the knob in direction "A" to extend the blade, or in direction "B" to retract the blade. When the knob is turned by one scale unit, the blade moves approximately 0,1 mm. One full turn of the knob moves the blade approximately 0,5 mm.

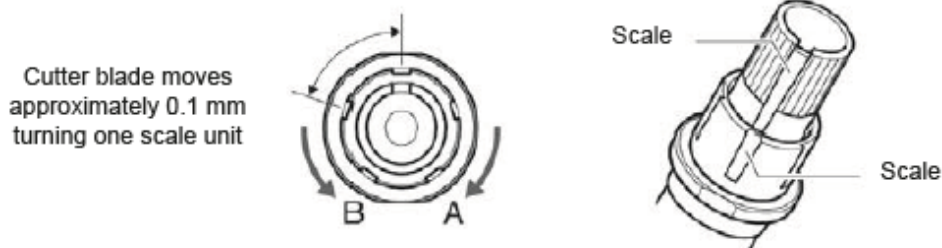

## 5A2 Mounting the tool

1. Loosen the tool holder screw.

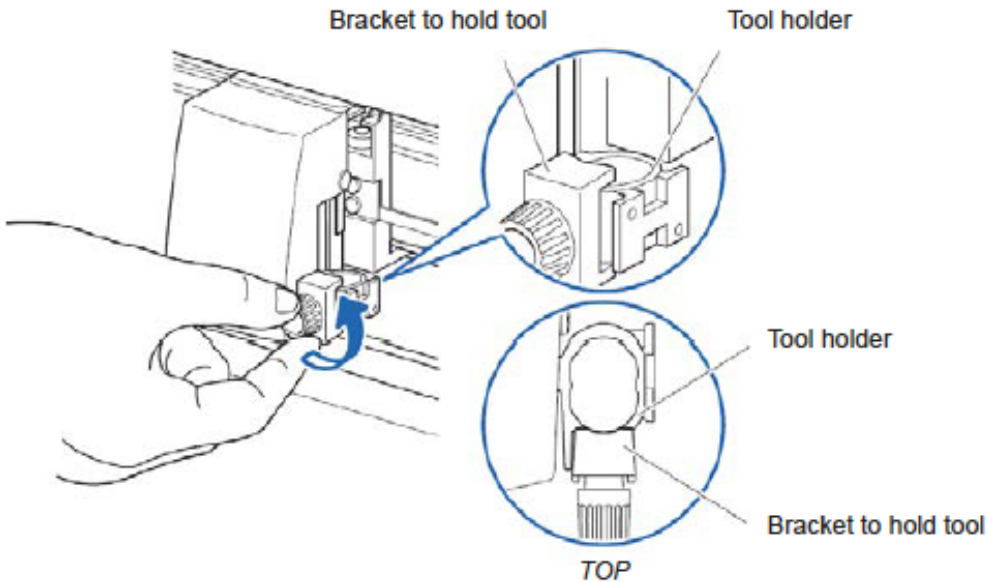

2. While pushing up the tool holder, push until its flange completely touches the upper part of the holder.

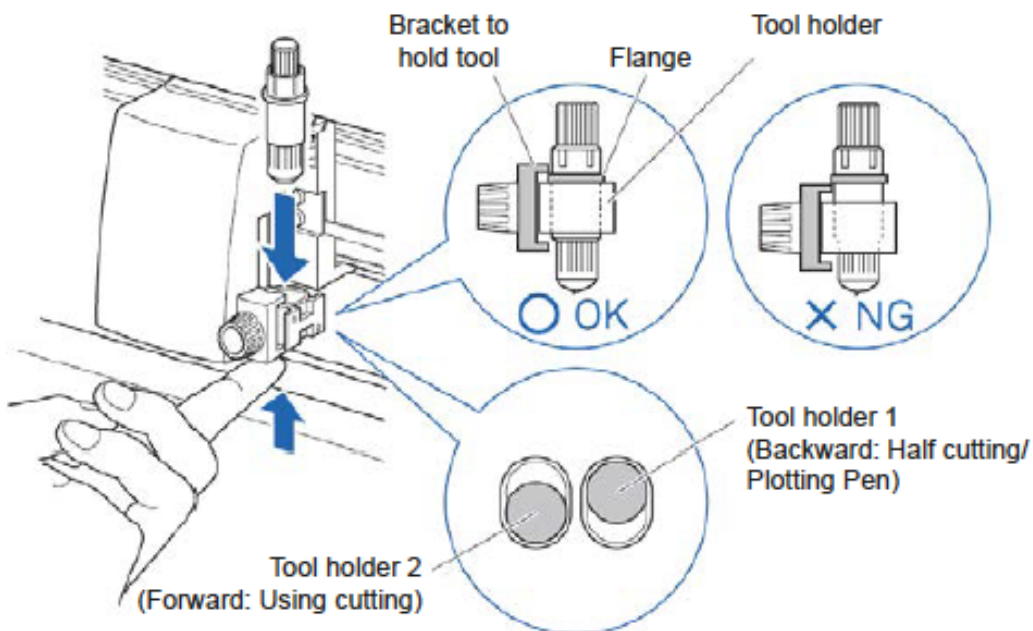

### SUPPLEMENT:

When using with half cutting and plotter pen, set the seal in Tool Holder 1 (backward), and when using cutting out (perforated cut), set the seal in Tool Holder 2 (forward).

3. Make sure that the tool bracket is engaged on the tool's flange, and then tighten the screw.

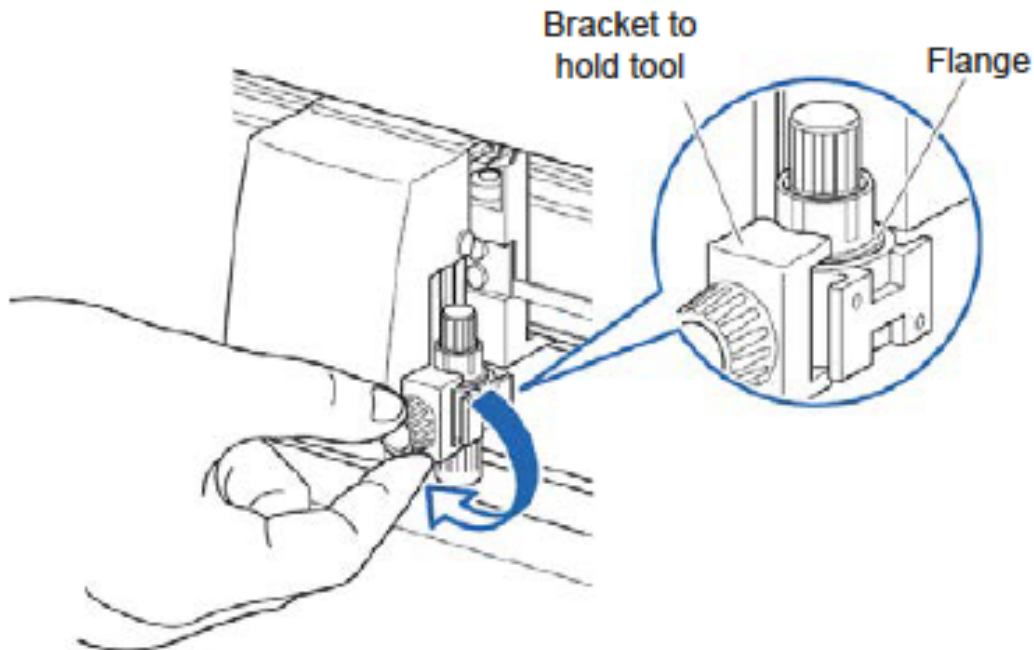

### 5A3 Removing the tool

When removing the tool, turn it counter-clockwise to remove the tool.

### 5A4 How to replace the knife

1. Turn the blade-length adjustment knob in the direction of the B arrow and pull the blade into the plunger.

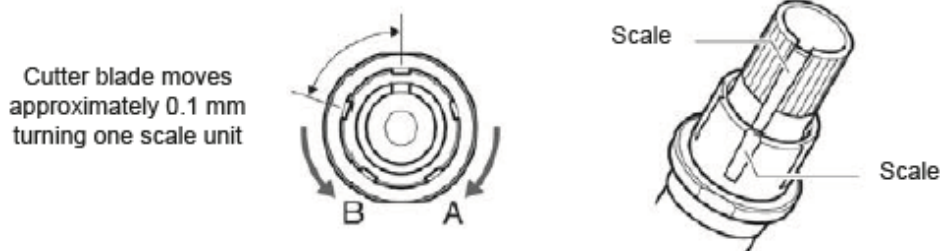

2. Turn the plunger cap in the counter-clockwise direction to remove it from the plunger.

3. Remove the blade from inside the plunger cap.

4. Remove a new blade from its pack. Insert the new blade into the hole provided in the plunger cap.

5. With the blade inserted into the plunger cap, screw on the plunger from above.

6. Fix the plunger cap by turning it clockwise.

**ATTENTION:** In order to preserve the lifespan of the plotter knife and not to wear it out quickly, make sure to properly calibrate the knife exposure and cut force depending on the media thickness

## 5A5 How to replace the slitter blade



- 1 Remove the two screws holding the blade in place.
2. Replace the blade.
3. Replace the two screws holding the blade in place.

## 5A6 How to replace the cutting mat

### CAUTION:

Please turn off the power when replacing the cutting mat. Please move the tool carriage to "A" position allowing for ease of work.

1. Remove the cutting mat

The cutting mat is attached to the cutting base (fig.2)

Please remove only the cutting mat from the cutting mat base from the location shown by the arrow (A) (fig.1)

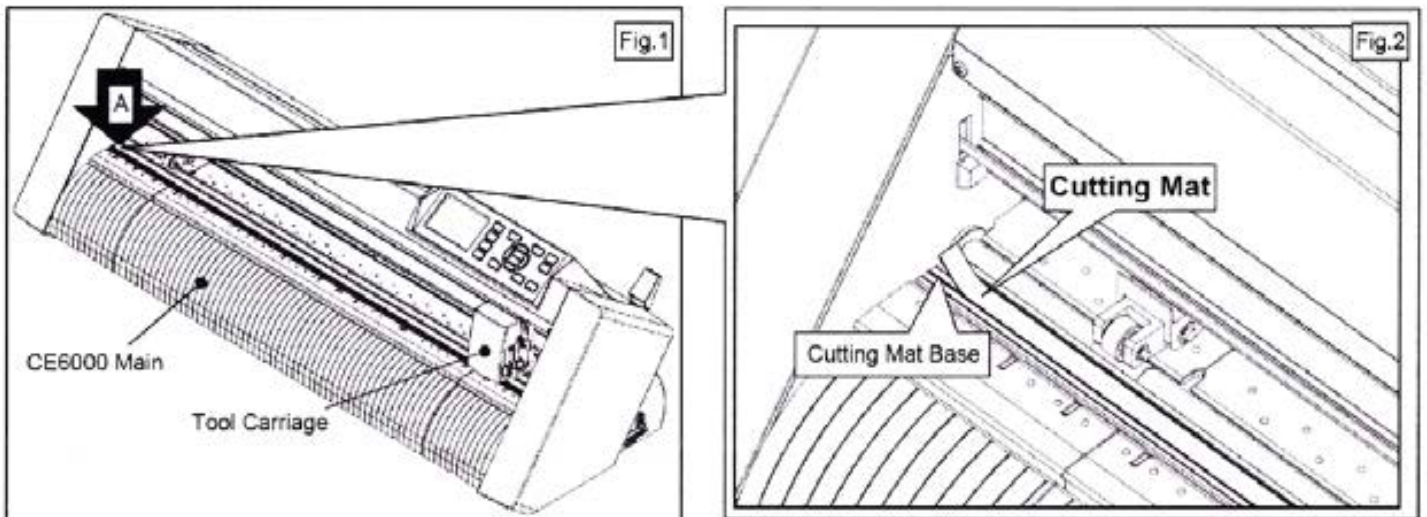

After removing the cutting mat, please make sure that there is no adhesive tape or other adhesives left on the cutting base. Please clean the cutting mat base before installing the cutting mat. Installing the cutting mat with the remaining adhesive may affect cut quality.

## 2. Installing the cutting mat

Fit the cutting mat with the front cutting base grooves (fig.3) and attach it from the location shown by the arrow (A) (fig.1) while peeling off the release paper.

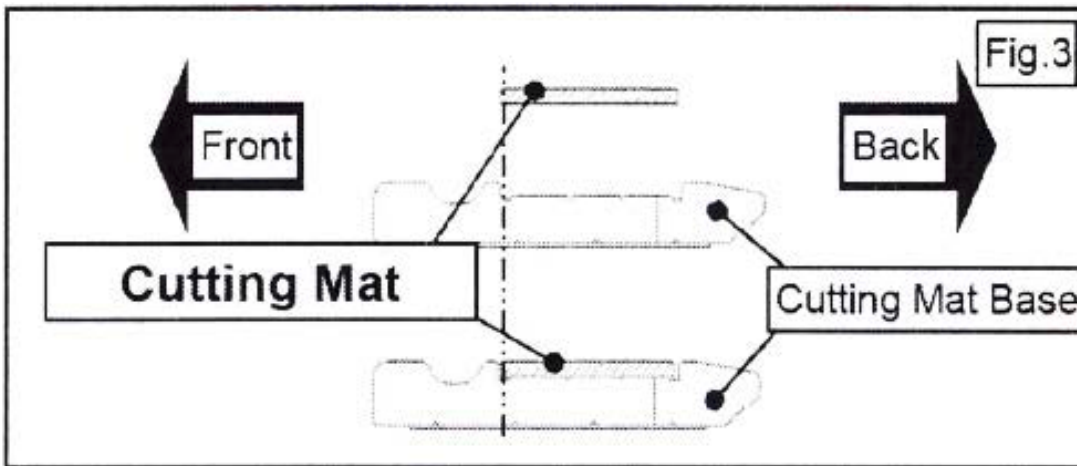

## 5A7 Ultrasonic Sensor Calibration

1. Turn OFF the main power "ON-OFF" red switch.
2. Raise up the tension arm up to the desired position (generally it is in the middle of the range). In that position, the system will reach the maximum winding's speed. The longer your label will be, the lower tension arm position requires to be set.
3. Holding the tension arm idle at the desired position, keep pushed "Forward Media" button, in the mean time turn ON the main power red switch and wait until the yellow led will have flashed 3 times and an acoustic beep signal will have been issued.
4. The ultrasonic sensor has been calibrated and ready to be operative.

## 5A8 Ultrasonic Sensor Calibration

1. Keeping ON the main power "ON-OFF" red switch. Turn "OFF" the module (both led are off).
1. Raise up the tension arm up to the desired position (generally it is in the middle of the range). That point will determinate the tension arm working range from the bottom position. The longer your label will be, the lower tension arm position requires to be set.
2. Holding the tension arm idle at the desired position, using a paper clip, keep pushed the button into the small hole until the yellow led will have flashed 3 times.
3. The ultrasonic sensor has been calibrated and ready to be operative.

5A9 Modules Speed Rotation  
Laminating & Unwinding Module  
ULTRASONIC TENSION CONTROLLER

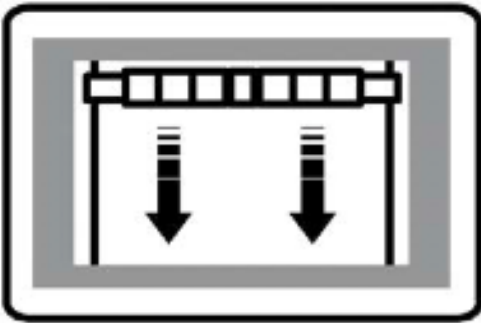
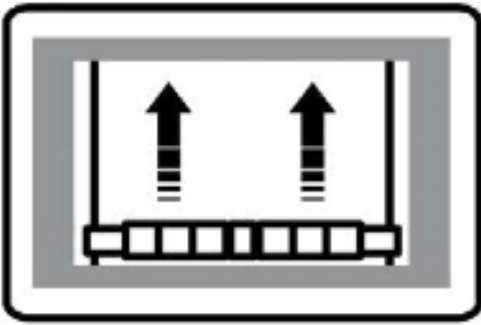

Waste Removing & Rewinding Module  
ULTRASONIC TENSION CONTROLLER

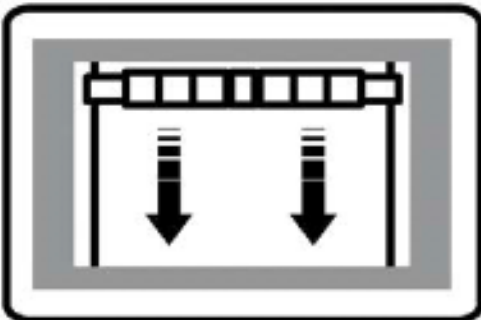
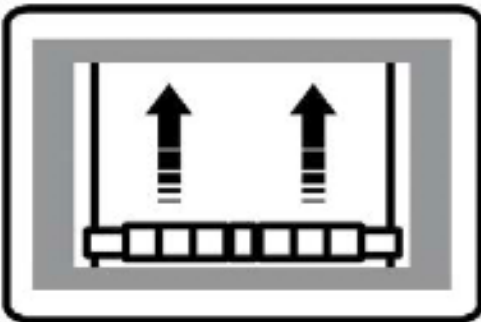

## 5B Error messages

If the plotter is not correctly connected to the computer, the following errors will be displayed at application launch:

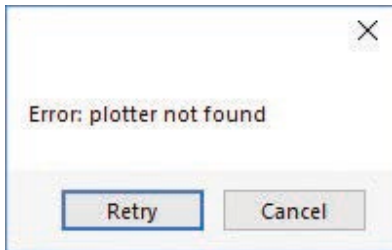

Ensure the media is loaded properly. Raise the lever on the plotter, then press the number 2 on control panel. Wait until the display shows "READY" as its status. Then, press retry on the pop-up window.

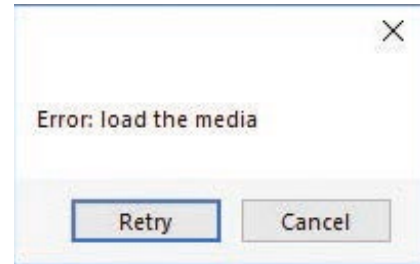

Make sure the plotter is switched on and properly connected. In case it is turned off, turn the plotter on and then press the button 2 on the control panel. Wait until the display shows "READY" as its status. Then, press retry on the pop-up window.



**Cause:** The plotter might be switched off or not properly connected.

**Fix:** Make sure the plotter is turned on and properly connected. In case it is turned off, please turn the plotter on and then press the button 2 on control panel and wait until the display will show "READY" as status. Then press retry on the pop-up window.



**Cause:** You launched the Cutting Manager while the plotter's lever was down.

**Fix:** Rise the lever on the plotter, then press the button 2 on control panel and wait until the display will show "READY" as status. Then press retry on the pop-up window.



**Cause:** the software has been opened while the dongle (the red key) was not plugged to the internal hub or the USB from the LF140e was not plugged to the PC.

**Fix:** Plug the dongle to the hub, or the LF140e USB to the PC and click retry.

### Error after opening a PDF file

**Cause:** -

- The anti virus doesn't allow the software to open the file
- The file is loaded from a server web or a remote disk  
This may create issues sometimes
- The file is not properly built

**Fix:**

- Add the cutting manager to your anti virus white list
- Move your file to your computer
- The cutting file must contain only
- The contours lines
- The black mark, in case of black mark mode cutting

---

## 5C Troubleshooting

### 5C1 Yellow and Green LED's simultaneously on lamination control board

This will also create the following error:



**Cause:** The DTM LF140 Digital Finishing Systems is equipped with two reflective sensors on the lamination module. One is the media sensor, located right after the first two guide rollers, and the other is the lamination sensor, mounted between the two black knobs on the rubber roller assembly. When both the yellow and green LED's on lamination control panel are on, it would indicate that either one or both of the sensors have picked up an error and the cause could be due to either the media or lamination roll has run out or the sensors may be out of sync and needs to be re-calibrated. The following steps below will show you how to tell when each sensor is in error mode and how to correct it or help you re-calibrate each sensor if needed.

### 5C2 Media Sensor

The media sensor is used to detect the presence of the media. The LED on this sensor should always be **ON** after the media has been loaded properly through all the guides; this would also indicate that the sensor is in good working condition.

#### Things to remember about this sensor:

- If the LED on this sensor is OFF after the media roll has been loaded and both the yellow and green LED's on the control panel comes on, it could indicate that media has ran out and needs to be changed.
- If after loading the media through the guides and the LED is still **OFF** or **BLINKING** with the yellow and green LED's on the control panel being on, it would indicate that the sensor is out of sync and needs to be re-calibrated.

#### Recalibrating the Media Sensor:

This operation has to be done while the media is loaded.

Hold down the calibration button located on the media sensor until the LED flashes off then on. The result should be a solid LED on the sensor.



## 5C3 Laminating Sensor

The lamination sensor is used to detect the presence of the lamination material. The LED on this sensor should always be OFF after the lamination roll has been loaded properly; it would also indicate that the sensor is in good working condition.

This sensor should always be covered with a blue cap should you decide NOT to use lamination on your media.

### Things to remember about this sensor:

- If the LED on this sensor is ON after the lamination roll has been loaded with both the yellow and green LED's on the control panel being on, it could indicate that lamination roll has ran out and would need to be changed.
- If the LED is still ON after loading the lamination roll with both the yellow and green LED's on the control panel being on, it would indicate that the sensor is out of sync and needs to be re-calibrated.

### Re-calibrating Lamination Sensor:

This operation has to be done with the lamination roll in place.

1. Locate the small screw on the lamination sensor.
2. Turn the screw on the sensor either clockwise or counter clockwise until the LED on the sensor turns off. If calibrated properly, the LED should stay OFF when the lamination roll is detected and turn ON when lamination roll has run out.

## 5C4 Media not aligned properly

**Problem:** If the media is not aligned properly after running a couple of jobs.

**Cause:** This problem occurs for a couple of reasons. The primary reason would be that the tension force on the on the rubber roller assembly, media core and the lamination core (If using lamination) are all out of sync and needs adjusting. Another reason could be that the media was wounded unevenly to begin with thus creating an uneven media roll.

Make sure the distance between top to top black-marks is set correctly.

**Fix:** First check to see if you have a flat even media roll before you begin installation. An uneven media roll will cause the job to misalign itself. If that checks out ok, then you will need to adjust the tension force on the lamination module. To do this you must turn the two black knobs located at the top the rubber roller assembly to adjust the tension force until you receive satisfactory results. If needed, this may have to be done in conjunction with adjusting the clutch tension on both the lamination core (If using lamination) and the material core using the aluminium handles. Adjust the tension force at all three locations accordingly until you get the perfect setting and the media is properly aligned.

---

## 5C5 Plotter error E01017 Hardware X Position Alarm Power off then on



**Problem:** The plotter displays an error E01017 Hardware X Position Alarm Power off then on.

**Cause:** The plotter will give you this error after starting a job in DTM LF140e Cutting Manager and the tensioner arm was not set-up to begin with or the tensioner arm was positioned too high after turning on the lamination module.

To set the tensioner arm properly, the arm must always be at a midpoint position or lower before turning on the lamination module.

**Fix:**

1. To set-up the tensioner arm, first turn off lamination module. The lamination module must be off for the next steps to work.
2. Use the arrow buttons at the top of the control panel to manually feed the media forward until the arm descends into the correct position. Correct position for the tensioner arm will be midpoint or lower.
3. Once Tensioner is in the correct position, turn ON lamination module. If done successfully, the tensioner arm will automatically re-adjust itself thus activating the unwinder motor.
4. Restart LF140e Cutting Manager software.

## 5C6 Plotter is not cutting or Plotter cutting all the way through the material

**Problem:** After starting a job, you notice that the plotter is not producing a clean cut through the media or the plotter is cutting all the way through the media.

**Cause:** This happens if cut force in or blade exposure may be set too low if it's not producing a clean cut or if it's cutting all the way through the media it could be set too high.

**Fix:** If the plotter is not producing a clean cut, this can be fixed by either; increasing the cut force in LF140e CM while decreasing the blade exposure until the unit provides satisfactory results or you can also decrease the cut force and increase the blade exposure until it produces a perfect cut. Adjust both accordingly until the correct cut setting has been achieved.

If the plotter is cutting through the media, this can be fixed by decreasing both the cut force and blade exposure to factory settings and start by increasing the cut force until you get a clean cut. You may have to increase the blade exposure while decreasing the cut force there's a clean cut and the correct settings is has been achieved.

You can continue to increase the blade exposure if necessary, but remember that when you increase the blade exposure, do not simultaneously increase the cut force or you will cut through the cutting mat below the media. It is always best to increase one setting while decreasing the other or just increasing one setting only, normally the blade. Never increase both settings simultaneously.

## 5C7 Plotter error E01019 Hardware Y Position Alarm Power off then on



**Problem:** The plotter displays an error E01019 Hardware Y Position Alarm Power off then on.

**Cause:** This error occurs when the blade tray was moved from side to side by the user after loading the media onto the plotter and with the rear plotter lever in the up position.

**Fix:** To fix this error, you must first power off the plotter, turn the plotter back on, wait for the display on the plotter to load, then press the number 2 as instructed on the plotter to complete the set-up.

## 5C8 Plotter error E05004 Hardware Realign Push Rollers Confirm



**Problem:** The plotter displays an error E05004 Hardware Realign Push Rollers Confirm.

**Cause:** This error occurs when the pinch rollers are not aligned properly with the plotter's grips.

**Fix:** Before feeding the material through the plotter (While the rear lever is in the down position) be sure that the pinch rollers are aligned properly with the plotter's grips.

## 5C9 Cutting Manager error Black-mark not found

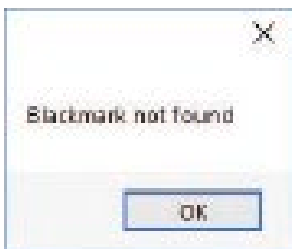

**Problem:** After starting a job in LF140e Cutting Manager, you get an error Black-mark not found.

**Cause:** This problem occurs when after you start the job and the software can't detect the black-mark on the media. The reason for this could be the following; the media is missing a marker to begin with; the media is not aligned with the arrows points labelled on the front and back of the plotter; the plotter's camera is not positioned correctly; and the plotter's camera is picking up too much exposure from the sunlight or another light source.

**Fix:** To fix this, before you start any job in LF140e Cutting Manager, be sure to always do the following; check and make sure the media has a black-mark printed on it to begin with; manually aligned the media with the arrows points labelled on the front and back of the plotter (This is done with the plotter's rear handle in the down position); make sure to position the plotter's camera over the black-mark in order to centred marker as much as possible on the software camera preview.

---

## 5C10 The Media or Lamination roll might be finished, please check it. Proceed with cutting?

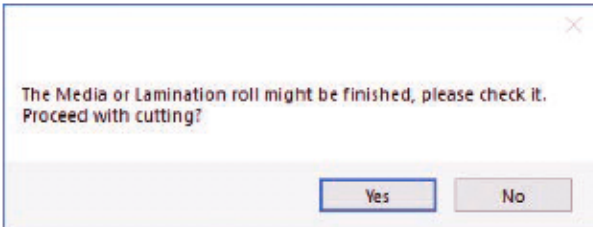

**Problem:** Yellow and Green light simultaneously on lamination control board.

**Cause:** When both the yellow and green LEDs on lamination control panel are on, it would indicate that either the media or lamination sensor have picked up and error or the sensors may be out of sync and needs to be calibrated.

**Fix:** To fix this, please refer to the "Yellow and Green LED's simultaneously on lamination control board" guide above to resolve.

## 5C11 Can't load sensors



**Cause:** Media/Lamination sensors might be not plugged in correctly or turned off.

**Fix:** Check if sensors are powered up and plugged correctly into the black sensor box. Then Retry. If you do not want to keep activated the sensors, click Ignore.

## 5C12 Last job not found



**Cause:** You will get this error when you try to open the last job when you run Cutting Manager for the first time after the installation.

**Fix:** Choose your file through "Open PDF".

### 5C13 Please forward the media to the next black-mark



**Cause:** The starting Y position of the cut is a negative value (you can see coordinates on plotter's display when you move the media with arrows). Keep in mind also the offset influences the starting position of the cut. If you start the cut at Y coordinates 0, while you have an offset Y value of -10, you will still get this error. This error might happens when the media has been just loaded.

**Fix:** Move to the next black-mark. If it is not enough, forward until you have reached Y coordinate value major than 0.

### 5C14 Please forward the media to reach a positive Y value shown on the plotter's display



**Cause:** The starting Y position of the cut is a negative value (you can see coordinates on plotter's display when you move the media with arrows). This error might happens when the media has been just loaded.

**Fix:** Move forward until you have reached positive Y coordinates.

## 5D How to Restore Plotter Settings

1. Turn off the plotter.
2. Turn on the plotter while keeping pushed the UP arrow on the panel.

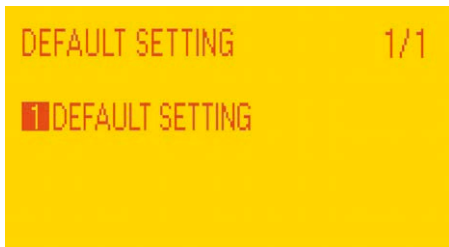

3. When the display shows "DEFAULT SETTING" press button 1.

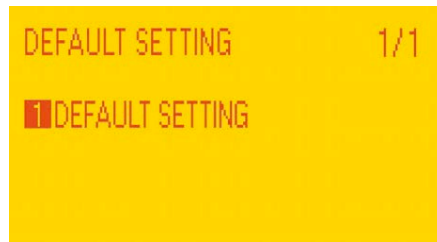

4. Press button 1.



5. Press button 1.



6. In process.



7. When the display shows "SET DEFAULT COMPLETE" turn off the plotter.



8. Turn on the plotter and Choose the language and press enter.



9. Select metric by pressing button 1 and then enter.



10. Press button 2.



11. Wait until on the display appears "READY".



12. Press "PAUSE/MENU" then go to I/F (press up arrow key).



13. Go to command (press 2).



14. Select GPGL (press 1 then enter).

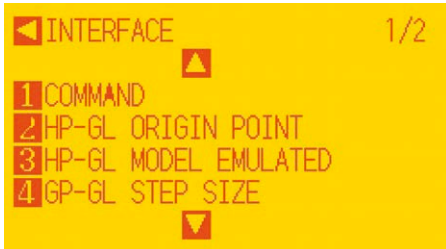

15. Press "PAUSE/MENU".



16. Restart plotter then press button 2.



17. Wait until on the display appears "READY".



18. Open the Cutting manager and click on "Advanced" and then select "Init cutter". Click "YES" to confirm



19. Wait until "Init cutter completed" will be shown in the status bar. Plotter display will show "LABEL MEDIA" as status.

# Section 6: Technical Specifications

---

## Technical Specifications

<b>Input / Output</b>	
<b>max. roll diameter:</b>	200 mm (7.87")
<b>Media width:</b>	100 mm (3.94") - 140 mm (5.51")
<b>Max. cutting width:</b>	122 mm (4.80")
<b>Label length:</b>	10 mm (0.39") - 350 mm (13.77")
<b>Min. slitting width:</b>	19 mm (0.75")
<b>Number of slitting blades:</b>	Max. 6
<b>Roll core size:</b>	76 mm (3")
<b>Max. media thickness:</b>	0.23 mm (0.05 mil)
<b>Max. cut speed:</b>	600 mm/s (24 in/s) in all directions
<b>Controls:</b>	Integrated 11.6" touch screen PC
<b>Power requirements:</b>	100 V-240 V AC, 50/60 Hz
<b>Energy consumption:</b>	29 W Idle, 60 W Active (100 W peak)
<b>Certifications:</b>	UL, UL-C, CE, FCC Class A
<b>Dimensions (WxHxD) and weight:</b>	<b>LF140e:</b> 116 cm x 68 cm x 78 cm 108 kg <b>Work table:</b> 124 cm x 79 cm x 88 cm 49 kg <b>Shipping palette:</b> 137 cm x 93 cm x 101 cm <b>Total weight:</b> 225 kg
<b>Warranty:</b>	3 years (wearable parts 1 year)

## Plotter Specifications

<b>Linear cut speed:</b>	Dependent on shape complexity
<b>Programmable cutting force:</b>	4.41 N (450 ) in 38 steps
<b>Cut precision:</b>	+/- 0.3 mm (0.012")
<b>Drive method:</b>	Digital servo drive
<b>Test cut function:</b>	Yes
<b>Black mark registration:</b>	Camera recognition via 2 mm <sup>2</sup> or 4 mm <sup>2</sup> black-mark
<b>Display:</b>	Graphic type LCD with backlight (240 dots x 128 dots)
<b>Cut ability:</b>	Printed and blank media
<b>Data interface:</b>	RS-232C / USB 2.0
<b>CPU:</b>	32-bit CPU
<b>Interface &amp; Software:</b>	DTM Print LF140e Label Finishing Software
<b>Certifications:</b>	UL, UL-C, CE, FCC Class A
<b>Manufacturer:</b>	Graphtec





For free label samples send an email to: [sales@dtm-print.eu](mailto:sales@dtm-print.eu)

Scan the QR Code to see the DTM LF140e product video or visit  
our YouTube channel: [www.youtube.com/c/dtmprint](http://www.youtube.com/c/dtmprint)

### Technical DTM Print Support

Contact the DTM Print support team Mondays - Thursdays from 9:00 - 17:00 and Fridays from 9:00 - 15:00 using the online live chat at the webpage [dtm-print.eu](http://dtm-print.eu), fill out the online support form at [support.dtm-print.eu](http://support.dtm-print.eu) or write us anytime an email to [support@dtm-print.eu](mailto:support@dtm-print.eu).

This service is free for all our customers.



DTM Print GmbH  
Mainzer Strasse 131  
65187 Wiesbaden  
Germany  
Tel.: +49 611 92777 0  
Email: [sales@dtm-print.eu](mailto:sales@dtm-print.eu)  
[dtm-print.eu](http://dtm-print.eu)

